

Name _____ Date ___ / ___ / ___

Track location			
Track name			
Track length	m		
Race Event			
Practice	Qualifying	Final	
Race duration	min.		
Track layout	technical	fast	mixed
Traction	low	medium	high
Temperature	Air	Track	
Results	Laps	Time	Position
	Fastest lap	Tank duration	

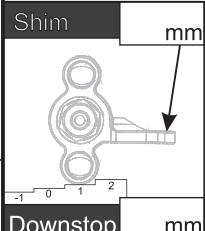

Engine			
Brand	Type		
Glowplug	Shims		
Carburator	Venturi		
Exhaust			
Manifold			
Muffler			
Fuel	Brand	Nitro	%

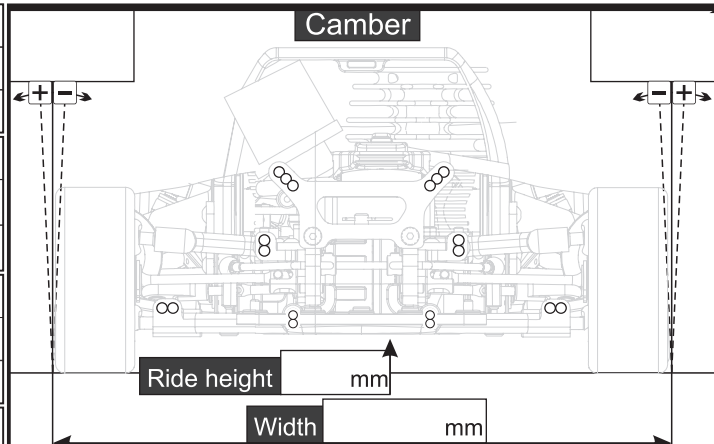
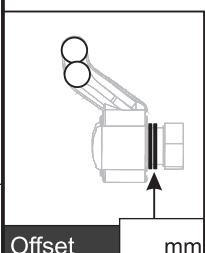
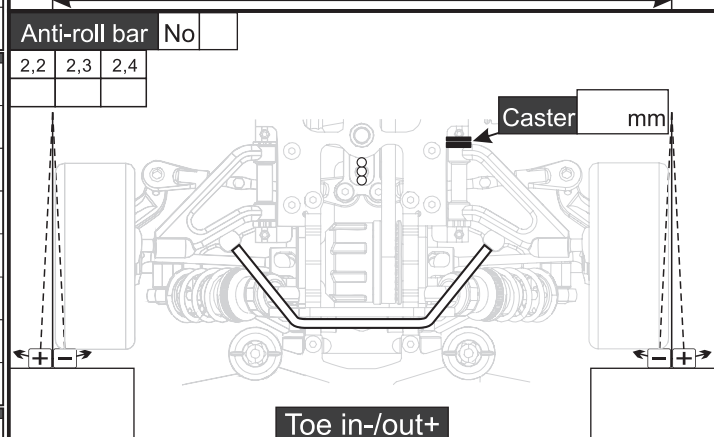

Clutch	Type		
Clutch shoe	Flyweights	Spring	
Bell clearance	Preload		

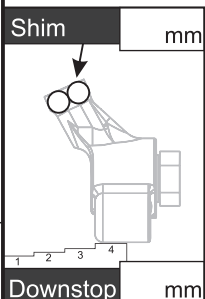
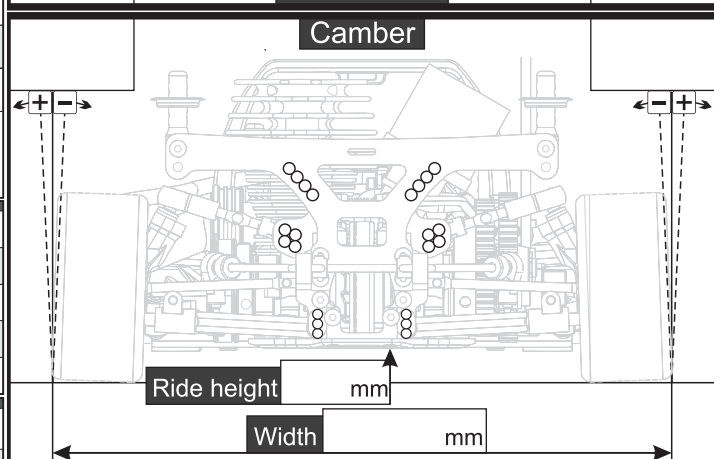

Drive ratio			
1st gear clutch bell	2nd gear clutch bell		
16 17 18	21	22 23	
1st gear gearbox	2nd gear gearbox		
58 59 60	53	54 55	

Tyres			
Front left/right	Brand	Rear left/right	
/	Shore	/	
/	Diameter start	/	
/	Diameter end	/	

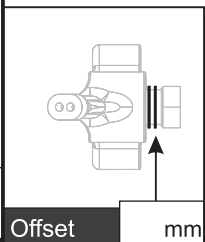
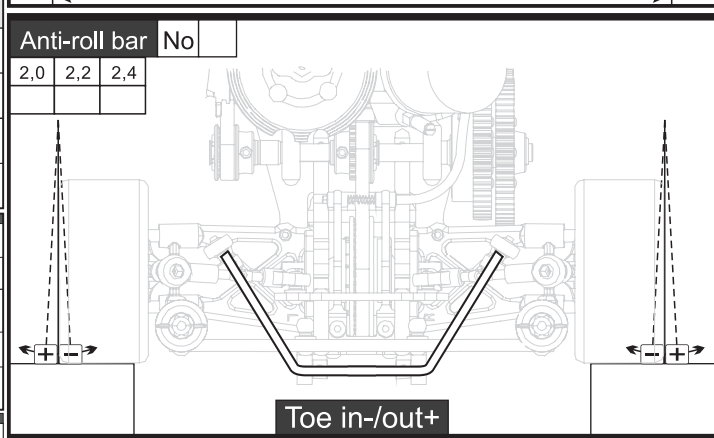

Front differential			
Differential	Solid axle	One way	
Oil	cST		
Rear differential			
Oil	cST		

Body	Brand	Type		
Distance from bumper	mm			
Spoiler	width	mm	height	mm
Position	distance to body rear		mm	
Winglets	mm x		mm	

Rear Shocks			
Piston	1hole	2hole	3hole
Spring floating piston	Soft	Hard	
Shock oil	Extra-Soft		
Spring			

Front Shocks			
Piston	1hole	2hole	3hole
Spring floating piston	Soft	Hard	
Shock oil	Extra-Soft		
Spring			

Notes